

FEIDER
MACHINES



ANGLE GRINDER 1050W

FM1125-A

USE GUIDE

CAUTION: Read the instructions before using the product.

CONTENTS

1. SAFETY INSTRUCTIONS	3
2. PRODUCT DESCRIPTION	7
3. SPECIFICATION	8
4. USE	8
5. REPLACEMENT OF PARTS AND MAINTENANCE	10
6. DISPOSAL	11
7. DECLARATION OF CONFORMITY	11
8. WARRANTY	12
9. PRODUCT FAILURE	13
10. WARRANTY EXCLUSIONS	14

1. SAFETY WARNINGS

GENERAL POWER TOOL SAFETY WARNINGS

WARNING Read all safety warnings, instructions, illustrations and specifications provided with this power tool. *Failure to follow all instructions listed below may result in electric shock, fire and/or serious injury.*

Save all warnings and instructions for future reference.

The term "power tool" in the warnings refers to your mains-operated (corded) power tool or battery-operated (cordless) power tool.

1) Work area safety

a) **Keep work area clean and well lit.** *Cluttered or dark areas invite accidents.*

b) **Do not operate power tools in explosive atmospheres, such as in the presence of flammable liquids, gases or dust.** *Power tools create sparks which may ignite the dust or fumes.*

c) **Keep children and bystanders away while operating a power tool.** *Distractions can cause you to lose control.*

2) Electrical safety

a) **Power tool plugs must match the outlet. Never modify the plug in any way. Do not use any adapter plugs with earthed (grounded) power tools.** *Unmodified plugs and matching outlets will reduce risk of electric shock.*

b) **Avoid body contact with earthed or grounded surfaces, such as pipes, radiators, ranges and refrigerators.** *There is an increased risk of electric shock if your body is earthed or grounded.*

c) **Do not expose power tools to rain or wet conditions.** *Water entering a power tool will increase the risk of electric shock.*

d) **Do not abuse the cord. Never use the cord for carrying, pulling or unplugging the power tool. Keep cord away from heat, oil, sharp edges or moving parts.** *Damaged or entangled cords increase the risk of electric shock.*

e) **When operating a power tool outdoors, use an extension cord suitable for outdoor use.** *Use of a cord suitable for outdoor use reduces the risk of electric shock.*

f) **If operating a power tool in a damp location is unavoidable, use a residual current device (RCD) protected supply.** *Use of an RCD reduces the risk of electric shock.*

3) Personal safety

a) **Stay alert, watch what you are doing and use common sense when operating a power tool. Do not use a power tool while you are tired or under the influence of drugs, alcohol or medication.** *A moment of inattention while operating power tools may result in serious personal injury.*

b) **Use personal protective equipment. Always wear eye protection.** *Protective equipment such as a dust mask, non-skid safety shoes, hard hat or hearing protection used for appropriate conditions will reduce personal injuries.*

c) **Prevent unintentional starting. Ensure the switch is in the off-position before connecting to power source and/or battery pack, picking up or carrying the tool.** *Carrying power tools with your finger on the switch or energising power tools that have the switch on invites accidents.*

d) **Remove any adjusting key or wrench before turning the power tool on.** *A wrench or a key left attached to a rotating part of the power tool may result in personal injury.*

e) **Do not overreach. Keep proper footing and balance at all times.** *This enables better control of the power tool in unexpected situations.*

f) **Dress properly. Do not wear loose clothing or jewellery. Keep your hair and clothing away from moving parts.** *Loose clothes, jewellery or long hair can be caught in moving parts.*

g) If devices are provided for the connection of dust extraction and collection facilities, ensure these are connected and properly used. *Use of dust collection can reduce dust-related hazards.*

h) Do not let familiarity gained from frequent use of tools allow you to become complacent and ignore tool safety principles. *A careless action can cause severe injury within a fraction of a second.*

4) Power tool use and care

a) Do not force the power tool. Use the correct power tool for your application. *The correct power tool will do the job better and safer at the rate for which it was designed.*

b) Do not use the power tool if the switch does not turn it on and off. *Any power tool that cannot be controlled with the switch is dangerous and must be repaired.*

c) Disconnect the plug from the power source and/or remove the battery pack, if detachable, from the power tool before making any adjustments, changing accessories, or storing power tools. *Such preventive safety measures reduce the risk of starting the power tool accidentally.*

d) Store idle power tools out of the reach of children and do not allow persons unfamiliar with the power tool or these instructions to operate the power tool.

Power tools are dangerous in the hands of untrained users.

e) Maintain power tools and accessories. Check for misalignment or binding of moving parts, breakage of parts and any other condition that may affect the power tool's operation. If damaged, have the power tool repaired before use. *Many accidents are caused by poorly maintained power tools.*

f) Keep cutting tools sharp and clean. *Properly maintained cutting tools with sharp cutting edges are less likely to bind and are easier to control.*

g) Use the power tool, accessories and tool bits etc. in accordance with these instructions, taking into account the working conditions and the work to be performed. *Use of the power tool for operations different from those intended could result in a hazardous situation.*

h) Keep handles and grasping surfaces dry, clean and free from oil and grease. *Slippery handles and grasping surfaces do not allow for safe handling and control of the tool in unexpected situations.*

5) Service

a) Have your power tool serviced by a qualified repair person using only identical replacement parts. *This will ensure that the safety of the power tool is maintained.*

SAFETY INSTRUCTIONS FOR ALL OPERATIONS

Safety Warnings Common for Grinding, Sanding, Wire Brushing, Polishing or Abrasive Cutting-Off Operations

a) This power tool is intended to function as a grinder or cut-off tool. Read all safety warnings, instructions, illustrations and specifications provided with this power tool. *Failure to follow all instructions listed below may result in electric shock, fire and/or serious injury.*

b) Operations such as sanding, wire brushing, polishing are not to be performed with this power tool. *Operations for which the power tool was not designed may create a hazard and cause personal injury.*

c) Do not use accessories which are not specifically designed and specified by the tool manufacturer. *Just because the accessory can be attached to your power tool, it does not assure safe operation.*

d) The rated speed of the accessory must be at least equal to the maximum speed marked on the power tool. *Accessories running faster than their rated speed can break and fly apart.*

e) The outside diameter and the thickness of your accessory must be within the capacity rating of your power tool. *Incorrectly sized accessories cannot be adequately guarded or controlled.*

f) Threaded mounting of accessories must match the grinder spindle thread. For accessories mounted by flanges, the arbour hole of the accessory must fit the locating diameter of the flange. *Accessories that do not match the mounting hardware of the power tool will run out of balance, vibrate excessively and may cause loss of control.*

g) Do not use a damaged accessory. Before each use inspect the accessory such as abrasive wheels for chips and cracks, backing pad for cracks, tear or excess wear, wire brush for loose or cracked wires. If

power tool or accessory is dropped, inspect for damage or install an undamaged accessory. After inspecting and installing an accessory, position yourself and bystanders away from the plane of the rotating accessory and run the power tool at maximum no-load speed for one minute. *Damaged accessories will normally break apart during this test time.*

- h) **Wear personal protective equipment.** Depending on application, use face shield, safety goggles or safety glasses. As appropriate, wear dust mask, hearing protectors, gloves and workshop apron capable of stopping small abrasive or workpiece fragments. *The eye protection must be capable of stopping flying debris generated by various applications. The dust mask or respirator must be capable of filtering particles generated by the particular application. Prolonged exposure to high intensity noise may cause hearing loss.*
- i) **Keep bystanders a safe distance away from work area. Anyone entering the work area must wear personal protective equipment.** *Fragments of workpiece or of a broken accessory may fly away and cause injury beyond immediate area of operation.*
- j) **Hold the power tool by insulated gripping surfaces only, when performing an operation where the cutting accessory may contact hidden wiring or its own cord.** *Cutting accessory contacting a "live" wire may make exposed metal parts of the power tool "live" and could give the operator an electric shock.*
- k) **Position the cord clear of the spinning accessory.** *If you lose control, the cord may be cut or snagged and your hand or arm may be pulled into the spinning accessory.*
- l) **Never lay the power tool down until the accessory has come to a complete stop.** *The spinning accessory may grab the surface and pull the power tool out of your control.*
- m) **Do not run the power tool while carrying it at your side.** *Accidental contact with the spinning accessory could snag your clothing, pulling the accessory into your body.*
- n) **Regularly clean the power tool's air vents.** *The motor's fan will draw the dust inside the housing and excessive accumulation of powdered metal may cause electrical hazards.*
- o) **Do not operate the power tool near flammable materials.** *Sparks could ignite these materials.*
- p) **Do not use accessories that require liquid coolants.** *Using water or other liquid coolants may result in electrocution or shock.*

FURTHER SAFETY INSTRUCTIONS FOR ALL OPERATIONS

Kickback and Related Warnings

Kickback is a sudden reaction to a pinched or snagged rotating wheel, backing pad, brush or any other accessory. Pinching or snagging causes rapid stalling of the rotating accessory which in turn causes the uncontrolled power tool to be forced in the direction opposite of the accessory's rotation at the point of the binding.

For example, if an abrasive wheel is snagged or pinched by the workpiece, the edge of the wheel that is entering into the pinch point can dig into the surface of the material causing the wheel to climb out or kick out. The wheel may either jump toward or away from the operator, depending on direction of the wheel's movement at the point of pinching. Abrasive wheels may also break under these conditions.

Kickback is the result of power tool misuse and/or incorrect operating procedures or conditions and can be avoided by taking proper precautions as given below.

- a) **Maintain a firm grip on the power tool and position your body and arm to allow you to resist kickback forces.** Always use auxiliary handle, if provided, for maximum control over kickback or torque reaction during start-up. *The operator can control torque reactions or kickback forces, if proper precautions are taken.*
- b) **Never place your hand near the rotating accessory.** *Accessory may kickback over your hand.*
- c) **Do not position your body in the area where power tool will move if kickback occurs.** *Kickback will propel the tool in direction opposite to the wheel's movement at the point of snagging.*
- d) **Use special care when working corners, sharp edges etc. Avoid bouncing and snagging the accessory.**

Corners, sharp edges or bouncing have a tendency to snag the rotating accessory and cause loss of control or kickback.

- e) **Do not attach a saw chain woodcarving blade, segmented diamond wheel with a peripheral gap greater than 10mm or toothed saw blade.** *Such blades create frequent kickback and loss of control.*

ADDITIONAL SAFETY INSTRUCTIONS FOR GRINDING AND CUTTING-OFF OPERATIONS

Safety Warnings Specific for Grinding and Abrasive Cutting-Off Operation

- a) **Use only wheel types that are specified for your power tool and the specific guard designed for the selected wheel.** *Wheels for which the power tool was not designed cannot be adequately guarded and are unsafe.*
- b) **The grinding surface of centre depressed wheels must be mounted below the plane of the guard lip.** *An improperly mounted wheel that projects through the plane of the guard lip cannot be adequately protected.*
- c) **The guard must be securely attached to the power tool and positioned for maximum safety, so the least amount of wheel is exposed towards the operator.** *The guard helps to protect the operator from broken wheel fragments, accidental contact with wheel and sparks that could ignite clothing.*
- d) **Wheels must be used only for specified applications. For example: do not grind with the side of cut-off wheel.** *Abrasive cut-off wheels are intended for peripheral grinding, side forces applied to these wheels may cause them to shatter.*
- e) **Always use undamaged wheel flanges that are of correct size and shape for your selected wheel.** *Proper wheel flanges support the wheel thus reducing the possibility of wheel breakage. Flanges for cut-off wheels may be different from grinding wheel flanges.*
- f) **Do not use worn down wheels from larger power tools.** *A wheel intended for larger power tool is not suitable for the higher speed of a smaller tool and may burst.*

ADDITIONAL SAFETY WARNINGS SPECIFIC FOR GRINDING AND CUTTING-OFF OPERATIONS

Additional Safety Warnings Specific for Abrasive Cutting-Off Operations

- a) **Do not “jam” the cut-off wheel or apply excessive pressure. Do not attempt to make an excessive depth of cut.** *Overstressing the wheel increases the loading and susceptibility to twisting or binding of the wheel in the cut and the possibility of kickback or wheel breakage.*
- b) **Do not position your body in line with and behind the rotating wheel.** *When the wheel, at the point of operation, is moving away from your body, the possible kickback may propel the spinning wheel and the power tool directly at you.*
- c) **When the wheel is binding or when interrupting a cut for any reason, switch off the power tool and hold it motionless until the wheel comes to a complete stop. Never attempt to remove the cut-off wheel from the cut while the wheel is in motion otherwise kickback may occur.** *Investigate and take corrective action to eliminate the cause of wheel binding.*
- d) **Do not restart the cutting operation in the workpiece. Let the wheel reach full speed and carefully re-enter the cut.** *The wheel may bind, walk up or kickback if the power tool is restarted in the workpiece.*
- e) **Support panels or any oversized workpiece to minimize the risk of wheel pinching and kickback.** *Large workpieces tend to sag under their own weight. Supports must be placed under the workpiece near the line of cut and near the edge of the workpiece on both sides of the wheel.*
- f) **Use extra caution when making a “pocket cut” into existing walls or other blind areas.** *The protruding wheel may cut gas or water pipes, electrical wiring or objects that can cause kickback.*





SPECIFIC SAFETY INSTRUCTIONS FOR ANGLE GRINDER

- a) When using a cut-off abrasive wheel guard for facial grinding, the wheel guard may interfere with the

workpiece causing poor control.

- b) When using a grinding wheel guard for cutting-off operating with the bonded abrasive wheels, there is an increased risk of exposure to emitted sparks and particles, as well as exposure to wheel fragments in the events of wheel burst.
- c) Only use the abrasive wheels which are recommended in this manual.

SYMBOLS

	WARNING-To reduce the risk of injury, user must read instruction manual.
	Electrical products must not be disposed of with the domestic waste.
	Protection class II (double insulation)
	Wear safety glasses.
	In accordance with essential applicable safety standards of European directives

2. PRODUCT DESCRIPTION



- | | | |
|--------------------|----------------------------|--------------------------------|
| 1) On / off switch | 5) Housing handle | 9) External flange with thread |
| 2) Drive shaft | 6) Protective cover | 10) Internal flange |
| 3) Side handle | 7) Lock button | 11) Safety button |
| 4) Gear box | 8) External flange spanner | |

3. SPECIFICATION

Rated voltage	230-240V~, 50Hz
Rated power	1050W
Rated no-load/ no:	11000/min
Spindle thread	M14
Max. Disc diameter	Φ125mm
Degree of Protection:	IPX0
Protection class:	II (double insulation)
Weight (without sander disc and dust collection box)	2,0 kg
Noise emission value according to EN 62841-2-4	
Sound pressure level L_{pA}	87,8 dB(A), K= 3dB(A)
Sound power level L_{WA}	98,4 dB(A), K= 3dB(A)
Vibration emission value according to EN 62841-2-4	
Work mode ah	14,213 m/s^2
Uncertainty K	1.5 m/s^2

INFORMATION:

- The declared vibration total value has been measured in accordance with a standard test method and may be used for comparing one tool with another.
- The declared vibration total may also be used in a preliminary assessment of exposure.



WARNING:

- The vibration emission during actual use of the power tool can differ from the declared values depending on the ways in which the tool is used especially what kind of workpiece is processed;
- It is necessary to identify safety measures to protect the operator that are based on an estimation of exposure in the actual conditions of use (taking account of all parts of the operating cycle such as the times when the tool is switched off and when it is running idle in addition to the trigger time).

4. USE

INTENDED USE`

This product is intended for cutting, rough cutting and brushing metal, concrete or tiles without the use of water. Any other uses or modification to the appliance is deemed to be improper usage and may result in serious physical injury. The manufacturer accepts no responsibility for damage(s) attributable to misuse. This product is designed for use by adults and not intended for commercial use.

BEFORE THE FIRST USE

Check if the package is complete and not damaged. If some parts are missed or are damaged, please do not use the tool and bring it back to your dealer.

ASSEMBLY



WARNING: The tool must be always switched off and unplugged before assembly!

1) Installation of the guard

- Put the protective guard (6) in the correct position (see below Fig. 1).
- Turn the guard to correct position (see below Fig. 2).
- Screw it firmly the guard. (see below Fig. 3).

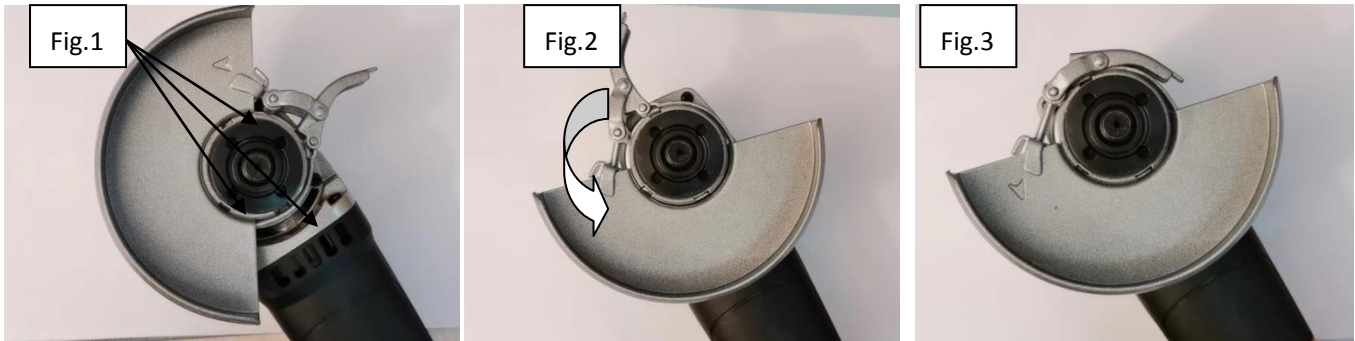

2) Installation of the disk(Fig.4)

- Place the inner flange on the spindle.
- Place then the corresponding disk.
- Place the outer flange the disk and screw it firmly with the pin wrench.
- Following the disk, the outer flange can be installed on the two sides:

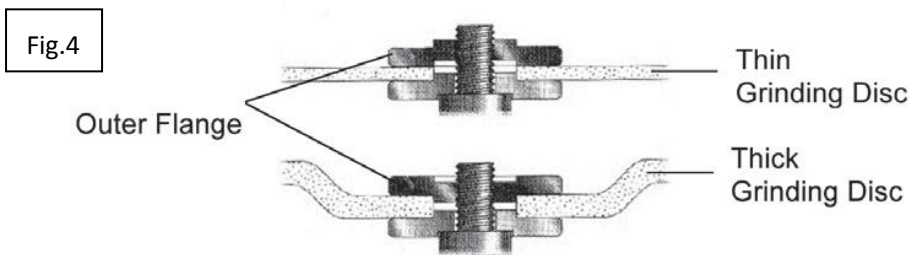

3) Installation of the auxiliary handle

- The auxiliary handle can be installed in 3 positions: top of the tool and both sides of the tool. The place where to install the auxiliary handle will depend of the position where you will use the tool. Screw firmly the handle with the provided wrench until it locks in place. See the operation part for install the handle according the position of tool.

OPERATION

- 1) Before switch on the tool, find the correct position to use the tool.
- 2) Plug the supply cord to a socket.
- 3) Hold the angle grinder by both hands, one hand hold the machine body and the other hold the auxiliary handle.
- 4) Double action to start the machine(Fig.5):
 - i. Press the safety switch (11)
 - ii. Press the ON/OFF switch (1)
- 5) To stop the operation, release the ON/OFF switch (1)

- **Rough grinding**

- For the best rough grinding results, hold the grinding wheel at an angle of between 30° and 40° to the work-piece surface and guide back and forth over the work-piece in steady movements.

- **Cutting**

- When you use the right-angle grinder for cutting

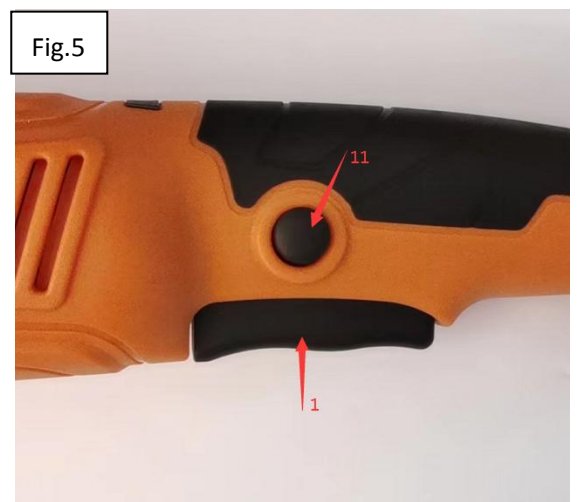

purposes, avoid tilting it in the cutting plane. The cutting wheel must have a clean cutting edge. A diamond cutting wheel is best used to cut hard stone. It is prohibited to use the machine on asbestos materials!

- Never use a cutting wheel for rough grinding.

- **Replace the disk (Fig.6)**

! WARNING: Beware – a disc which has been used may be very hot!

- 1) Pull out the power plug from the mains socket.
- 2) Depress and hold down the spindle lock button (7) to secure the spindle
- 3) Turn the shaft until it locks.
- 4) Remove the outer flange (a) and backing flange (b) by using the two-hole spanner provided.
- 5) Fit the desired disc (8) on the spindle and replace the outer flange and backing flange. Release the spindle lock.

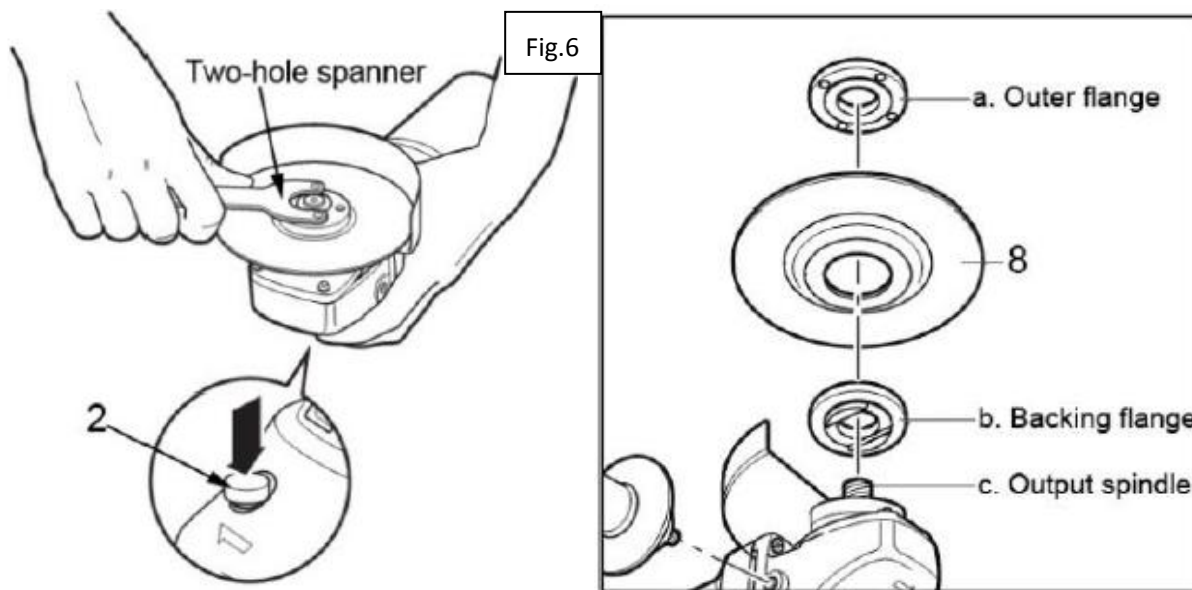

5. REPLACEMENT OF PARTS AND MAINTENANCE

Keep your tool on a regular basis. This will keep your tool in good working order and extend its lifespan.

Do not use abrasive or corrosive agents to clean the tool. These types of products damage your tool.

Do not make any repairs by yourself. Repairs and inspections should be carried out by a competent person or an authorized service center (please contact your dealer).

1) After each use

Check the condition of the accessories and the tool body (cleanliness, wear, damage, etc.). If you notice any damage, wear or malfunction, do not use the tool and take it to a qualified service for inspection and repair.

2) Servicing

No specific maintenance is required by the user. After each season, please bring the tool to an authorized service center for general machine maintenance.

3) Spare parts

You can order spare parts directly from our service center. Please place your order according to the type of machine and the part number indicated in the explosion drawing.

If the replacement of the supply cord is necessary, this has to be done by the manufacturer or his agent in order to avoid a safety hazard.

4) Storage

- After use and cleaning, please keep your tool.

- Store the tool in a clean, dry place, preferably in its box.
- When transporting and storing, always put the protective cover on the blade.
- The tool should be stored away from children and pets.
- Avoid exposing the tool to direct sunlight.

6. DISPOSAL



Electrical products should not be discarded with household products. According to the European Directive 2012/19/EC on waste electrical and electronic equipment and its implementation into national law, electrical products used must be collected separately and disposed of at collection points provided for this purpose. Talk with your local authorities or dealer for advice on recycling.

7. DECLARATION OF CONFORMITY



Declaration of conformity

BUILDER SAS

ZI, 32 RUE ARISTIDE BERGES – 312070 CUGNAUX – FRANCE

Declares that the machinery designated below:

ANGLE GRINDER 1050 W

Model number: FM125-A

S/N: 20220667186-20220667689

Complies with the provisions of the Directive « machinery » 2006/42/EC and national laws transposing it:

Also complies with the following European directives:

EMC Directive 2014/30/EU

ROHS Directive (EU)2015/863 amending 2011/65/EU

Also complies with European standards, with national standards and the following technical provisions:

EN 60745-1: 2009+A11:2010

EN 60745-2-3:2011+A2:2013+A11:2014+A12:2014+A13:2015

EN 55014-1:2017

EN 55014-2:2015

EN IEC 61000-3-2:2019

EN 61000-3-3:2013+A1 :2019

Cugnaux, 22/04/2022

Philippe MARIE / PDG

8. WARRANTY

The manufacturer guarantees the product against defects in material and workmanship for a period of 2 years from the date of the original purchase. It can be extended by one year if the user subscribes to website of myswap. The warranty only applies if the product is for household use. The warranty does not cover breakdowns due to normal wear and tear.

The manufacturer agrees to replace parts identified as defective by the designated distributor. The manufacturer does not accept responsibility for the replacement of the machine, in whole or in part, and/or ensuing damage.

The warranty does not cover breakdowns due to:

- insufficient maintenance.
- abnormal assembly, adjustment or operations of the product.
- parts subject to normal wear and tear.

The warranty does not extend to:

- shipping and packaging costs.
- using the tool for a purpose other than that for which it was designed.
- the use and maintenance of the machine done in a manner not described in the user manual.

Due to our policy of continuous product improvement, we reserve the right to alter or change specifications without notice. Consequently, the product may be different from the information contained therein, but a modification will be undertaken without notice if it is recognized as an improvement of the preceding characteristic.

READ THE MANUAL CAREFULLY BEFORE USING THE MACHINE.

When ordering spare parts, please indicate the part number or code, you can find this in the spare parts list in this manual. Keep the purchase receipt; without it, the warranty is invalid. To help you with your product, we invite you to contact us by phone or via our website:

+33 (0)9.70.75.30.30

<https://services.swap-europe.com/contact>

You must create a "ticket" via the web platform.

- Register or create your account.
- Indicate the reference of the tool.
- Choose the subject of your request.
- Describe your problem.

Attach these files: invoice or sales receipt, photo of the identification plate (serial number), photo of the part you need (for example: pins on the transformer plug which are broken).



9. PRODUCT FAILURE

WHAT TO DO IF MY MACHINE BREAKS DOWN?

If you bought your product in a store:

- Make sure that your machine is complete with all accessories supplied, and clean! If this is not the case, the repairer will refuse the machine.
- Go to the store with the complete machine and with the receipt or invoice.

If you bought your product on a website:

- Make sure that your machine is complete with all accessories supplied, and clean! If this is not the case, the repairer will refuse the machine.
- Create a SWAP-Europe service ticket on the site: <https://services.swap-europe.com> When making the request on SWAP-Europe, you must attach the invoice and the photo of the nameplate (serial number).

Contact the repair station to make sure it is available before dropping off the machine.

Go to the repair station with the complete machine packed, accompanied by the purchase invoice and the station support sheet downloadable after the service request is completed on the SWAP-Europe site

Please keep your original packaging to allow for after-sales service returns or pack your machine with a similar cardboard box of the same dimensions.

For any question concerning our after-sales service you can make a request on our website <https://services.swap-europe.com>

Our hotline remains available at +33 (9) 70 75 30 30.



10. WARRANTY EXCLUSIONS

THE WARRANTY DOES NOT COVER:

- Start-up and setting up of the product.
- Damage resulting from normal wear and tear of the product.
- Damage resulting from improper use of the product.
- Damage resulting from assembly or start-up not in accordance with the user manual.
- Breakdowns related to carburetion beyond 90 days and fouling of carburetors.
- Periodic and standard maintenance events.
- Actions of modification and dismantling that directly void the warranty.
- Products whose original authentication marking (brand, serial number) has been degraded, altered or withdrawn.
- Replacement of consumables.
- The use of non-original parts.
- Breakage of parts following impacts or projections.
- Accessories breakdowns.
- Defects and their consequences linked to any external cause.
- Loss of components and loss due to insufficient screwing.
- Cutting components and any damage related to the loosening of parts.
- Overload or overheating.
- Poor power supply quality: faulty voltage, voltage error, etc.
- Damages resulting from the deprivation of enjoyment of the product during the time necessary for repairs and more generally the costs related to the immobilization of the product.
- The costs of a second opinion established by a third party following an estimate by a SWAP-Europe repair station
- The use of a product which would show a defect or a breakage which was not the subject of an immediate report and/or repair with the services of SWAP-Europe.
- Deterioration linked to transport and storage*.
- Launchers beyond 90 days.
- Oil, petrol, grease.
- Damages related to the use of non-compliant fuels or lubricants.

* In accordance with transport legislation, damage related to transport must be declared to carriers within 48 hours maximum after observation by registered letter with acknowledgement of receipt.

This document is a supplement to your notice, a non-exhaustive list.

Attention: all orders must be checked in the presence of the delivery person. In case of refusal by the delivery person, it you must simply refuse the delivery and notify your refusal.

Reminder: the reserves do not exclude the notification by registered letter with acknowledgement within 72 hours.

Information:

Thermal devices must be wintered each season (service available on the SWAP-Europe site). Batteries must be charged before being stored.



BUILDER SAS
32, rue Aristide Bergès - ZI 31270 Cugnaux – France
Made in PRC 2022